

KALOS

ADDING WARMTH TO OUTDOOR LIVING

Terrace Floor Standing Electric Heater

KLEH150-0500



IMPORTANT

PLEASE KEEP THIS BOOKLET FOR FUTURE REFERENCE.
THIS IS IMPORTANT INFORMATION REGARDING THE USE AND
CARE OF YOUR HALOGEN HEATER.







ASSEMBLY
TIME



PERSONS
REQUIRED

Important Information

-  Unpack the halogen heater making sure that all the items are present and that there are no components left in the box and that the heater head is free from any packing material.
-  Using the detailed drawing follow the steps to assemble your halogen heater.
-  **DO NOT** connect the halogen heater to the electrical supply until all the assembly is complete.
-  **DO NOT** connect the halogen heater to the electrical supply if any of the components or the power cord is damaged in any way.

If in doubt contact your supplier.

Important advice before you begin:

This appliance is not intended for use by persons (including children) with reduced physical, sensory or mental capabilities or lack of experience and knowledge if they have been given supervision or instruction concerning use of the appliance in a safe way and understand the hazards involved.

Children should not play with the appliance.

Cleaning and user maintenance should not be made by children without supervision.

Do not use any other tools other than those recommended to build this product.

Please do not use substitute parts. Use only additional or replacement parts supplied by Kettler.

In the unlikely event that this product has missing or damaged parts, please visit our website www.kettler.co.uk/shop.

For Your Safety

Warning

- This heater is not equipped with a device to control the room temperature. **DO NOT** use this heater in small rooms when they are occupied by persons not capable of leaving the room on their own, unless constant supervision is provided.
- Children of less than 3 years should be kept away unless continuously supervised.
- Children under 8 years shall not plug in, regulate and clean the appliance or perform user maintenance

Caution

- Some parts of this product can become very hot and cause burns. Particular attention has to be given where children and vulnerable people are present.
- Only use the heater on a firm solid horizontal area where all the feet on the base are in contact with the floor. (Should the heater be tilted or fall over the auto cut off switch will activate)



1. Site the heater outside or in a large open area and well away from any obstructions such as branches or where the heater is near any objects that can be effected by heat, such as furniture, curtains or other inflammable objects (minimum distance 1 metre).
2. **DO NOT** use this heater in the immediate surroundings of a bath, a shower or a swimming pool. Do not use near water.
3. **DO NOT** use in unventilated areas
4. **DO NOT** use where gas, petrol, paint or other surely flammable goods are stored.
5. **DO NOT** push any items through, obstruct or cover the grill of the heater head.
6. **DO NOT** position immediately above or below an electrical socket.
7. **DO NOT** move when connected to an electrical supply and always wait for the patio heater to cool down before storing away.
8. **DO NOT** touch the heater when in use.
9. **DO NOT** leave turned on and unattended especially when children and or animals are in the vicinity.
10. The indication of the different positions of switches shall be visible from a distance of 1M.
11. The Marking concerning covering should be visible after the heater has been installed. It shall not be placed on the back of portable heaters.

For Your Safety

12. The unit must be placed with the clearance of 100cm to the wall.
13. The unit must be correctly installed according to the instructions.
14. The unit must be securely placed on a horizontal and flat surface.
15. The unit is at high temperature during operation. It keeps hot for a period after shut down. Potential danger would occur when touching it during this period. Unplug the unit and wait till it cools before cleaning.
16. **DON'T** place the unit close to curtain and/or other flammable objects. Otherwise there will be a danger of catching fire.
17. **DON'T** cover the unit with anything during operation or a short time after it's shut down.
18. **DON'T** wrap the power supply cord on the unit.
19. The unit must be handled with care, and avoid vibration or hitting.
20. The unit must be securely grounded during operation.
21. If the unit gets damaged, it must be repaired by professional electricians with relevant qualifications.
22. When the power supply cord is damaged, it must be replaced by a qualified engineer to avoid danger.
23. **DON'T** use this unit in place where causticity or volatile air exists, i.e. dust, steam, gas, etc.
24. **DON'T** use this unit as a cloth drier or towel drier.
25. **DON'T** use this unit as a sauna heater.
26. **DON'T** use this unit as a room heater.
27. **DON'T** use this unit in place of animal propagating and raising.
28. **DON'T** immerse this unit into water for cleaning.
29. The unit should be plugged in a socket, which is easily visible and reachable.
30. One dark point may exist on the surface of the heating elements during the first few minutes after it is turned on. This is normal, and will not affect the performance of the unit.
31. **DON'T** use this heater with a programmer, timer or any other device that switches the heater on automatically, since a fire risk exists if the heater is covered or positioned incorrectly.
32. Children should be supervised to ensure that they do not play with the appliance.
33. When assembling, keep clear from any board or flammable material.
34. The unit is for household use only. It is not safe to use on a building site, greenhouse, barn or stable where there's flammable dust.
35. An apparatus with CLASS I construction shall be connected to a MAINS socket outlet with a protective earthing connection.

Installation



WARNING! These appliances must be earthed.

Before installing or replacing the bulb, the appliance must be always being disconnected from the 220-240V supply.

Terrace Floor Standing Heater is built with the best quality components in accordance to the prevailing legal regulations and certified for safety in use. For best results from the appliance please ensure that the installation is done by a qualified electrician in accordance with the following instructions and taking full account of current regulations. When using the heater, please carefully follow the instructions and recommendations below.

Connection to 220-240 Volts Power Supply.

- It is important to ensure that the electricity supply is of adequate capacity for the electrical load required by the appliance being installed.

Minimum required distances:

- 250mm from the side wall
- 500 mm from the ceiling
- Generally heaters must be placed at a safe distance (clear space) of at least 2.0m from combustible materials and glass walls. If installed in workshops or garages where inflammable or combustible paints are used, the heaters must be installed at a distance of at least 4.0m from the source of danger.
- If the heaters are placed in areas where spray painting of any description is taking place, they should not be used during the painting operations.
- Never use the heater in particularly dusty and explosive areas.

Assembly

1

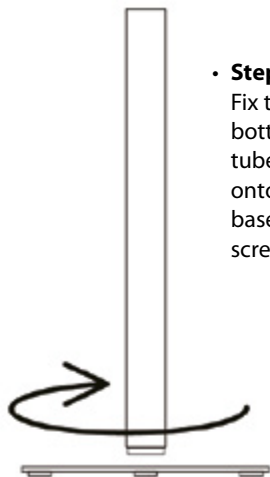

- **Step 1:** Fix the bottom tube onto the base by screwing.

2

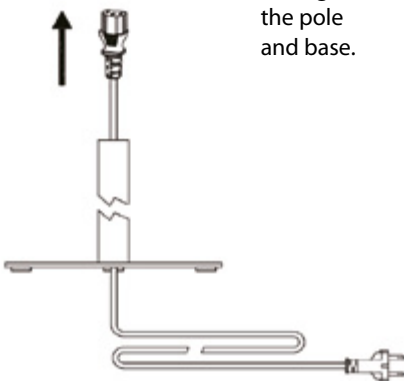

- **Step 2:** Pull the power cord through the pole and base.

3

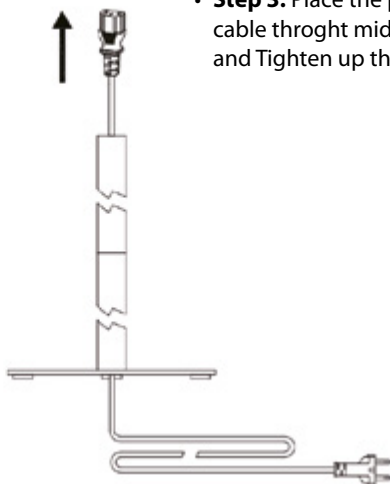
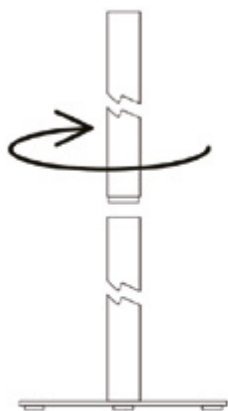

- **Step 3:** Place the power cable through middle tube, and Tighten up the tubes.

4

- **Step 4:** Place the power cable throught the top tube,and tighten up.

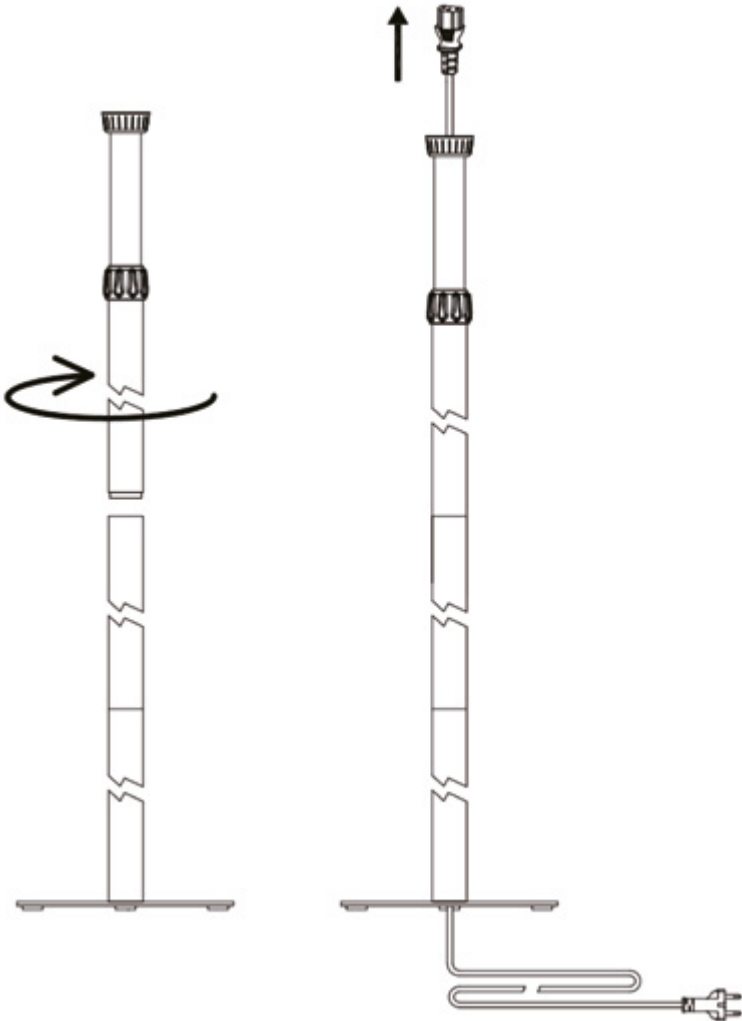

Assembly

5

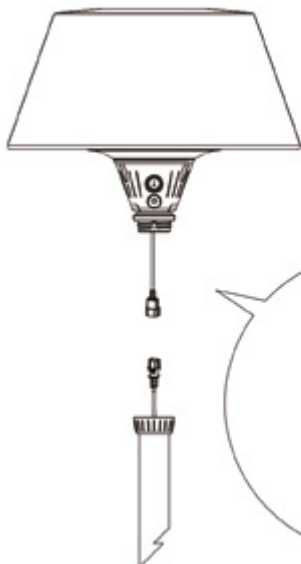

- **Step 5:** Connect the power cord plug to the socket in the heater head.

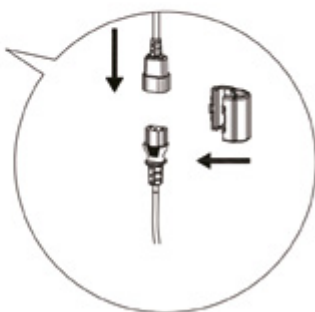

6

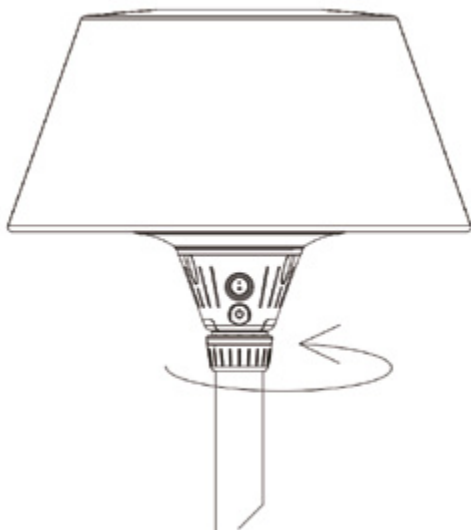

- **Step 6:** Connect the heater head with the tube by screwing them together.

Assembly

7

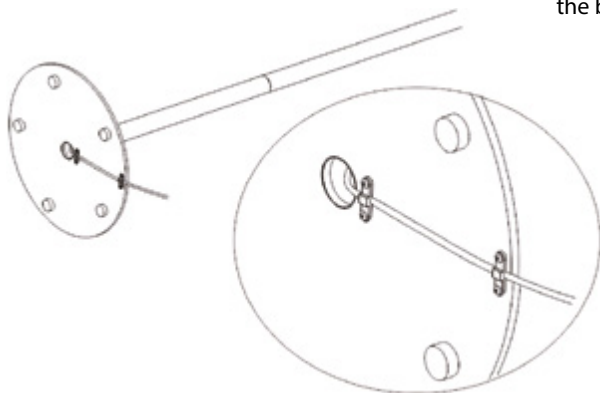

- **Step 7:** Fixed the power cord with the press clip in the base.

8



- **Step 8:** Fix the heater on the floor. Bore three holes in the floor, fix the heater by three wedge bolts on the floor tightening the screws by spanner.

Finished

Operating Instructions

Connect the power cable to a 220-240V, 13 amp supply that is located in a safe, dry area.

Press the button , the heater will be ready mode.

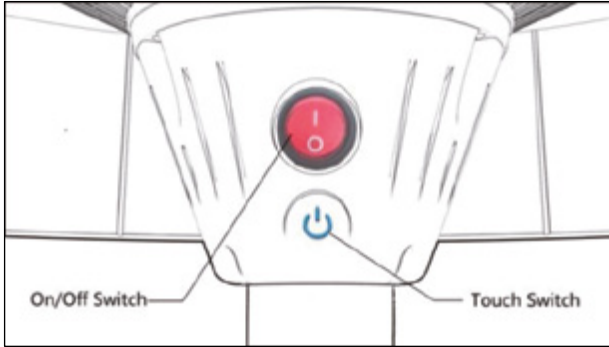

- Touch the touch switch once, the heater will be on 800W.
- Touch the touch switch twice, the heater will be on 1200W.
- Touch the touch switch three times, the heater will be on 2000W.
- Touch the touch switch four times, the heater will be on standby.
- Press the button , the heater will turn off.

Remote Control

- Press the LOW button, the heater will be on 800W.
- Press the High button, heater will be on 1200W.
- Press the LOW and High button at the same time, heater will be on 2000W.

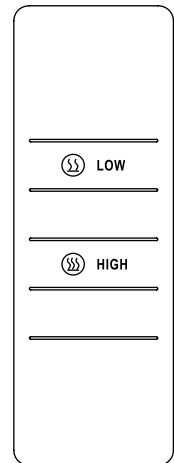

Operating Instructions

Trouble Shooting

If the heater will not operate, please check the following before seeking repair of service:

- Check if the power cord is plugged into an electrical outlet, if not plug in.
- Check if electricity to the main fuse is working.
- Make certain the power switches are turned on. If not, choose a setting.

Technical specification

- Power supply 220-240V, 50-60Hz
- Wattage max 2000W
- Insulation class I



WEEE: This product contains recyclable materials. Do not dispose this product as unsorted municipal waste. Please contact your local municipality for the nearest collection point.

Maintenance and Care Instructions

- Unplug the unit and let it cool completely.
- When disconnected from the electrical supply, clean the outside of the patio heater with a damp cloth. Never use corrosive or solvent cleaners or immerse in water.
- Any maintenance or repairs including replacing the halogen tube should only be carried out by a qualified electrician or by a recommended service center.

Storage

- If the heater will not be used for a long period of time, store it in a cool, dry location when not in use. To prevent dust and dirt build-up, use the original packaging to repack the unit.

KETTLER



www.kettler.co.uk



Warranty For Home Use

This product is covered by a 12 month warranty against manufacturing faults. This warranty applies to domestic use only. It does not cover commercial use, mis-use or accidental damage.

To validate your warranty, register at www.kettler.co.uk and quote the product code from the front of this booklet.