

















PRODUCT ASSEMBLY

Before you begin the assembly of your new purchase please read instructions carefully:

1. Please check all components listed are counted and correspond to the required parts for building the product (should there be anything missing please contact your retailer or help@supremouk.com).
2. This Product should be assembled by 2 people.
3. NEVER USE A POWER TOOL TO ASSEMBLE.
4. To ensure your product is not damaged during assembly, prepare a suitable area to build your furniture, either assemble on a clean soft surface (like a carpet) or use the box the products have been supplied in. This will prevent your product from damage / scratching to the materials used when building the furniture.
5. To begin the assembly, follow the diagrams in order sequence as directed to ensure the correct method is followed for correct installation of each component. DO NOT tighten any bolts up until all parts have been connected loosely with all bolts inserted into position, once all parts are connected, then each bolt can be fully tightened using the tools provided.
6. Thank you for purchasing a Supremo product and we wish you many years of enjoyment using your garden furniture.

Component List

A		1	Glass
B		1	Table Top Frame
C		1	Table Leg with Door
D		1	Table Leg
E		1	Leg Side Panel with Control Panel Hole
F		1	Leg Side Panel
G	 M6X20	4	Bolts
H	 M6X35	12	Bolts
I		16	Metal Washer
J		1	Allen Key
K		16	PVC Bolt Cover
L		1	Fire Pit
M		1	Glass Surround
N		1	Heat Proof Tape
O		2	Alu Plate to fasten control panel

Please Note: Components L, M & N are supplied in a separate box

Catalan 110x110cm Mini Modular Firepit Dining Table

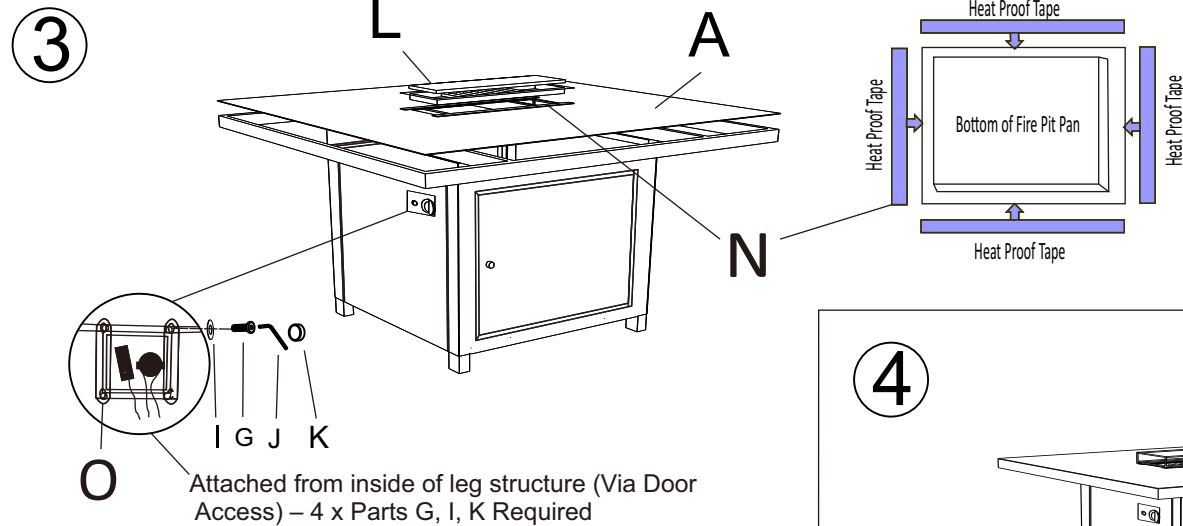
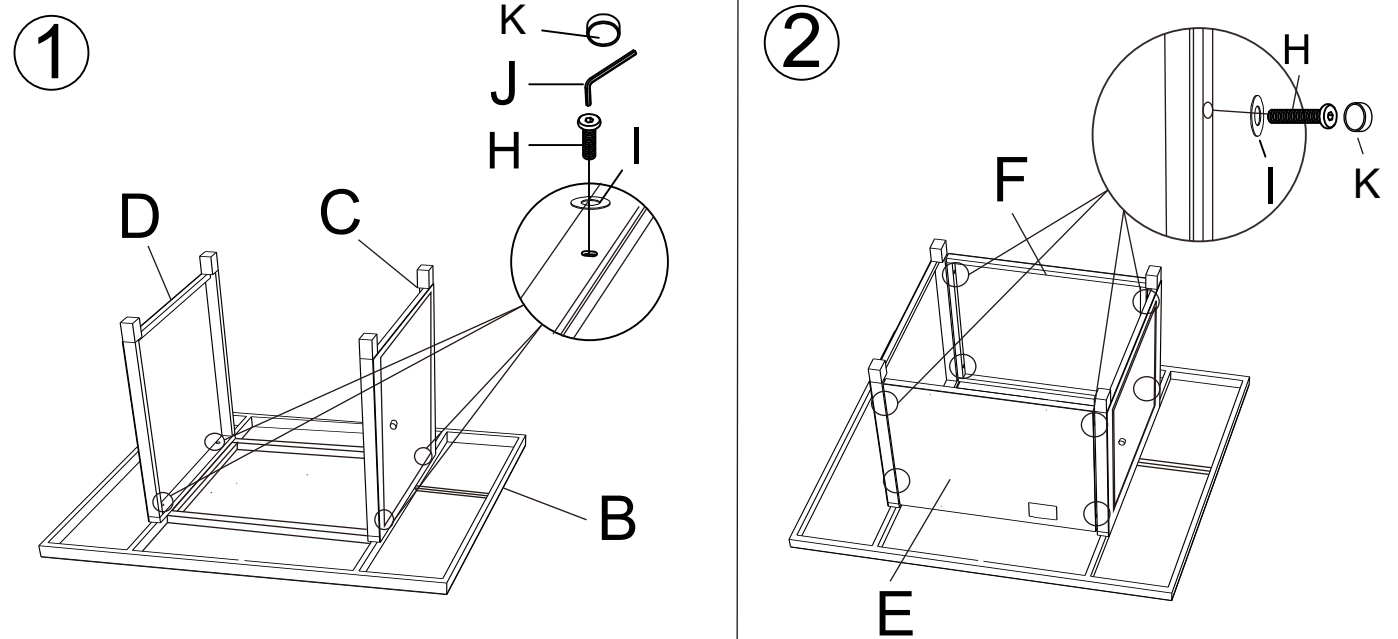

1. Turn the main fire bowl onto its face edge (up-side down) onto a soft level surface.
2. Apply the heat proof tape to the 4 outer rim edges of the fire bowl ensuring the tape is placed level with the outer edges and cut the tape to the correct length required (ensure the tape does not overlap each other where the tape can join in the corners).

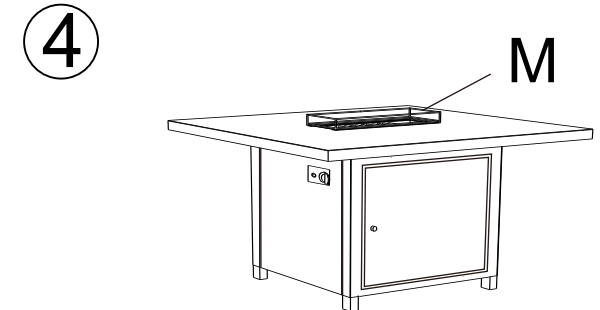

See Instructions inside original box for Glass surround assembly